

TYPE OF ICE

USES & APPLICATIONS



TYPE OF ICE

GOURMET ICE



Alfa Mini



Gala



Pulsar



Delta Max



Super Star



Super Star Plus

FEATURES

- Pure, transparent, crystalline ice, without hollows or ridges.
- Perfect for drinks and cocktails.
- Spin around the cup and the ice cooled without water down.
- ITV produce this ice in 6 sizes.



HOLLOW ICE CUBE



Quasar

FEATURES

- Easy manipulation, very versatile.
- Reliable machine.
- Designed to produce ice in the most adverse conditions of water quality and temperature.
- Melt very fast.



FULL DICE & HALF DICE CUBE



Spika Dice



Spika Half Dice

FEATURES

- Perfect ice for fast-food and large consumption of ice.
- Ice that cool the drink at full speed.
- Automatically dispensable ice.
- Ideal for soft drinks.
- ITV produce this ice in 2 shapes (full and half dice).



NUGGET ICE



Nugget

FEATURES

- Perfect ice for mixed drinks. Gently mixes the flavours without watering down the drink.
- Also used to cool fruit juices or yoghurts at food displays.
- Moisture content of 10%.
- Compact texture, halfway between ice cube and crushed ice, evenly chopped.
- Crunchy ice that does not detract from the flavour of the drink.



GRANULAR ICE



Diamond

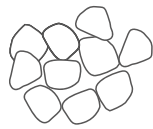

Chip



Granular

FEATURES

- Perfect ice for supermarkets, transporting fish, fruit or vegetables, food expositions, health and industry.
- Ice that cool at full speed.
- Temperature from 0°C to -1°C.
- 1,6 M³ is equal to 1 TM of ice.
- ITV produce this ice in 3 shapes (diamond, granular and chip).



FLAKE ICE



Scala

FEATURES

- Perfect ice for food industry, construction and transport.
- Flat flakes very cold and dry.
- Humidity 2%
- Temperature -7°C.
- 2M³ is equal to 1 TM of ice.



TYPE OF ICE

ICE CUBES



TURBO SYSTEM
SISTEMA TURBO

Pulsar

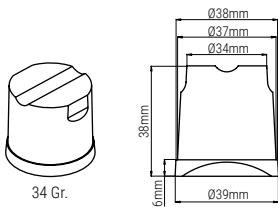

PRODUCTION KG/LB
From 25/50 to 145/300



PADDLE SYSTEM
SISTEMA DE PALETAS

Quasar

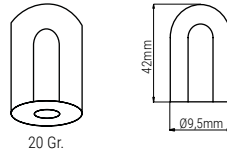

PRODUCTION KG/LB
From 20/35 to 190/420



VERTICAL SYSTEM
SISTEMA VERTICAL

Spika FD/HD

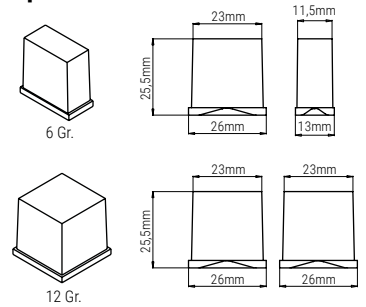

PRODUCTION KG/LB
From 60/115 to 400/880



SPRAY SYSTEM
SISTEMA DE DUCHAS

Mini Alfa

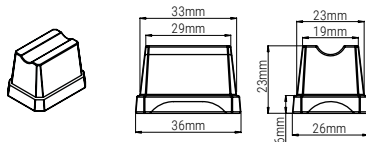

PRODUCTION KG/LB
From 20/35 to 400/883

Gala

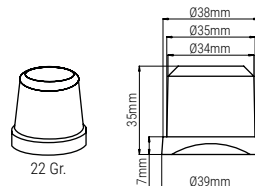

Delta Max

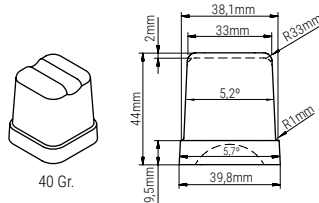

40 Gr.

Super Star +

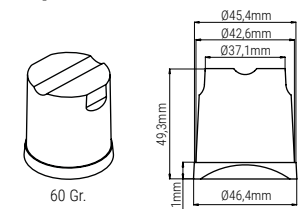

Super Star

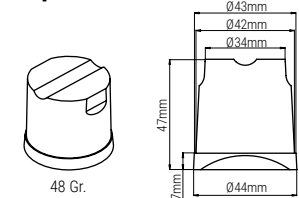

48 Gr.

NUGGET ICE

Nugget



NUGGET ICE

PRODUCTION KG/LB
From 300/661 to 500/1102

GRANULAR ICE

Ice Queen



DIAMOND ICE



GRANULAR ICE



CHIP ICE

PRODUCTION KG/LB
From 50/85 to 1100/2425

FLAKE ICE

























Scala













































FLAKE ICE







PRODUCTION KG/LB
From 400/750 to 50T/110K

ICE APPLICATIONS

	TYPE OF ICE	QUANTITY	RANGE
Traditional bar	 	0,1 Kg / customer	Alfa / Quasar
Café	 	0,04 Kg / customer	Gala / Quasar
Pub, Club		0,25 Kg / customer	Delta Max / Pulsar
Night Club		0,3 Kg / customer	Delta Max / Super Star Plus
Disco		0,3 Kg / customer	Super Star Plus
Premium drinks		2 ice piece / glass	Gala / Delta / Pulsar
Cocktails	 	3 ice piece / glass	Super Star Plus / Nugget
Soft drinks		3 ice piece / glass	Alfa / Gala / Delta Max / Pulsar
Fast Food		0,07 Kg / Glass SMALL	Spika
		0,11 Kg / Glass MEDIUM	Spika
		0,15 Kg / Glass LARGE	Spika
Standard restaurant	 	0,15 Kg / Customer	Alfa / Gala / Delta Max / Pulsar / Quasar
Restaurant	 	0,3 Kg / Customer	Alfa / Gala / Delta Max / Pulsar / Quasar
Seafood stablishment	 	0,5 Kg / Customer	Alfa / Gala / Delta Max / Pulsar / Quasar
		1,25 Kg / Customer	Ice Queen
Hotel		0,3 Kg / Room	Alfa / Gala / Delta Max / Pulsar
Camping		0,3 Kg / Plot	Alfa / Gala / Quasar
		0,8 Kg / Plot	Ice Queen
Residence		0,2 Kg / Room	Alfa / Gala / Quasar

 SOLID ICE CUBE
 FULL/HALF DICE
 HOLLOW CUBE
 NUGGET ICE
 GRANULAR ICE
 FLAKE ICE

	TYPE OF ICE	QUANTITY	RANGE
Food/Drink exposition	  	1 Kg / Simple ice bucket	Ice Queen / Quasar / Nugget
	  	6 Kg / Ice bucket	Ice Queen / Quasar / Nugget
Seafood tray	 	1,3 Kg / SMALL tray	Ice Queen / Scala
	 	3 Kg / MEDIUM tray	Ice Queen / Scala
	 	6 Kg / LARGE tray	Ice Queen / Scala
Buffet on ice 10cm.		70 Kg / m ²	Ice Queen
		12 Kg / gastronorm tray 1/1	Ice Queen
Fish market exposition		1m ² 10 cm 100 Kg	Ice Queen
		1m ² 10 cm 85 Kg	Scala
Fish market storage		0,30 Kg / 1 Kg fish	Ice Queen
Hospital		0,30 Kg / Patient	Alfa / Gala
Laboratory		1 Kg / Bucket	Ice Queen
		5 Kg / Fridge	Ice Queen
Phisiotherapy		0,80 Kg / Patient	Ice Queen
Rice-recuperation		0,5 Kg / Application	Ice Queen
Spa's-Ice shower		150 Kg / Shower	Ice Queen
Laser therapy		0,30 Kg / Patient	Ice Queen
Fish industry	 	Storage 0,30 Kg / 1 Kg fish	Ice Queen / Scala
	 	Cool embarked 1 Kg / 1 Kg pescado	Ice Queen / Scala
	 	Tropical embarked 1 Kg / 1 Kg fish	Ice Queen / Scala
Meat industry	 	0,25 Kg / 1 Kg	Ice Queen / Scala
Bakery industry	 	0,20 Kg / 1 Kg	Ice Queen / Scala
Dyes	 	0,50 Kg / 1 m ²	Ice Queen / Scala
Cement		50 Kg / 1 m ³	Scala

	SOLID ICE CUBE
	FULL/HALF DICE
	HOLLOW CUBE
	NUGGET ICE
	GRANULAR ICE
	FLAKE ICE

APPLICATIONS

HOSTELERÍA & QSR



APPLICATIONS

INDUSTRY



APPLICATIONS

RETAIL



HEALTHY





C/31270_06/AJ/21
ITV ICE MAKERS, S.L.
POL. IND. SECTOR 13, AVDA. DELS HOSTALERS, 2 46394
RIBARROJA DE TURIA, VALENCIA, SPAIN
PHONE: +34 96 166 75 75 | FAX: +34 96 166 81 00
comercial@itv.es | www.itv.es