

COMPATECH





Dal 1989 un punto di riferimento nella produzione di forni professionali di qualità made in Italy.

Inoxtrend nasce nel 1989 nella Inox Valley italiana e si caratterizza, fin dall'inizio, per l'attenzione rivolta alla specializzazione e alla ricerca continua di soluzioni adatte ad ogni cucina professionale per:

- Ristoranti
- Hotel
- Gastronomie
- Catene di ristorazione
- Coffee shop
- Bar
- Stazioni di servizio
- Panifici
- Pastifici

La risposta pronta alle esigenze dei clienti e la cura dei rapporti relazionali hanno permesso la continua crescita dell'azienda e la sua evoluzione.

Since 1989 a point of reference in the production of made in Italy quality professional ovens.

Inoxtrend was founded in 1989 in the Italian Inox Valley and is characterized, from the very beginning, by the attention paid to specialization and the continuous search for solutions suitable for every professional kitchen in:

- Restaurant
- Hotel
- Gastronomy
- Catering chain
- Coffee shop
- Bar
- Petrol station
- Bakery
- Pastry shop

The prompt response to customer needs and the care of relationships have allowed the company to continue growing and evolving.

COMPATECH

SOLUZIONE COMPATTA

COMPATECH COMPACT SOLUTION

Compatech è la risposta ideale per tutti gli chef che sono alla ricerca di una cucina efficiente ed ottimizzata. Designer e ingegneri hanno lavorato con il massimo impegno per ridurre al minimo gli ingombri senza sacrificare funzionalità e prestazioni.

Il risultato è un forno combinato elettrico e compatto, disponibile nelle versioni da 4 a 11 teglie ed impilabile, capace di garantire allo chef il massimo controllo sui programmi di cottura.

Adatto per preparazione di piatti sottovuoto, a vapore, essiccazioni, gratinature, rosolature, arrosti e pietanze di altro genere.

Nelle versioni touch il forno è dotato di modulo Wi-Fi integrato. La sua connessione alla rete aziendale tramite Nube cloud permette l'inserimento delle ricette e il controllo dei consumi da remoto.

Compatech is the ideal solution for all chefs who are after an efficient and optimized kitchen. Designers and engineers have committed to minimising this oven footprint without compromising on functionality and performance.

The result is a compact electric combined oven, available in versions with 4 to 11 trays and stackable, capable of guaranteeing the chef's maximum control over the cooking programs.

Suitable for preparing vacuum-packed, steamed, dried, gratin, browned, roast dishes and other type dishes.

In the touch versions the oven is equipped with an integrated Wi-Fi module. Its connection to the company network via Nube cloud allows you to enter recipes and monitor consumption remotely.



CARATTERISTICHE E VANTAGGI

Compactech è la soluzione di cottura professionale completa, dotata di display a colori ad alta leggibilità, comandi touch e maniglia ergonomica che velocizzano ogni operazione. La camera a tenuta stagna con spigoli interni raggiati agevola la pulizia, mentre l'illuminazione a LED consente l'accurato controllo visivo delle teglie risparmiando energia.

PLUSES AND FEATURES

Compactech is a complete professional cooking solution, equipped with a highly readable colour display, touch controls and ergonomic handle that speed up operations. The watertight chamber with rounded internal edges facilitates cleaning, while the LED lighting allows for accurate visual inspection of the trays, saving energy.



FUNZIONE DELTA T

La cottura in Delta T cioè basata sul differenziale (delta) di temperatura (T) è una particolare tecnica di cottura che usa una sonda per mantenere costante durante tutto il tempo di cottura la differenza fra temperatura della camera e quella al cuore del prodotto.

La funzione Delta T è configurabile da 1° a 150°C ed è attivabile selezionando la sonda al cuore.

DELTA T FUNCTION

Delta T cooking, based on temperature (T) differential (delta) settings, is a particular cooking technique that uses a probe to keep the difference between the temperature of the chamber and the core temperature of the food constant for the whole cooking time.

The Delta T function can be configured from 1° to 150°C and can be activated by selecting the core probe.



Funzioni multi level & multi cooking.
Multi level & multi cooking functions.



Maniglia con doppia impugnatura.
Double grip handle.



Schermo touch capacitivo da 5".
5" capacitive touch screen.



Tecnologia USB per software e ricette.
USB technology for software and recipes.



Programma di lavaggio automatico.
Automatic washing program.



Due velocità disponibili: ventilato o semistatico.
Two speeds available - ventilated or semi-static.

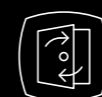

Porte reversibili anche dopo l'installazione.
Door opening side reversible even after installation.



Timing, da 1 minuto a 99:59 ore.
Timing from 1 minute to 99:59 hours.



Struttura in acciaio inossidabile.
Stainless steel structure.



 Capacity
4 levels × GN 2/3

 Capacity
4 levels × GN 1/1

 Capacity
7 levels × GN 1/1

 Capacity
11 levels × GN 1/1

 Power supply
Electric  Power (Kw)
3/4.3

 Power supply
Electric  Power (Kw)
5.2

 Power supply
Electric  Power (Kw)
8.8

 Power supply
Electric  Power (Kw)
15

 Voltage (V) Frequency (Hz)
220/240, 380/415 60

 Voltage (V) Frequency (Hz)
380/415 60

 Voltage (V) Frequency (Hz)
380/415 60

 Voltage (V) Frequency (Hz)
380/415 60

 Outside Dimension (cm)
L 52 D 68 H 72

 Outside Dimension (cm)
L 52 D 93 H 72

 Outside Dimension (cm)
L 52 D 93 H 93

 Outside Dimension (cm)
L 52 D 93 H 120

SALVA E PROGRAMMA LE TUE RICETTE

SAVE AND PROGRAM YOUR RECIPIES

Tramite il comodo ed intuitivo touch screen potrai scegliere fra le tante ricette internazionali, testate nei nostri laboratori, o salvare le tue negli oltre 1000 spazi disponibili.

Il software di programmazione ti aiuterà a replicare le ricette ogni volta che lo vorrai, ottenendo lo stesso risultato, oppure a trasferirle dal pannello di controllo in qualsiasi altro sistema SMART, come con il tuo Tablet o Smartphone.

Through the user-friendly, intuitive touch screen you can choose from many international recipes, tested in our laboratories, or upload yours to the over 1000 available slots.

The programming software will help you replicate any recipes whenever you want to obtain identical results, or transfer recipes from the control panel to any other SMART system, such as your tablet or smartphone.



MULTI RECIPIES

Ricettario diviso per tipologie di portata, come pasta e riso, carne, pollo, pesce, verdure, uova e pasticceria.

Recipe book divided by dish types, such as pasta and rice, meat, chicken, fish, vegetables, eggs and pastries.



MULTI LEVEL & COOKING

Questa funzione permette di cucinare piatti diversi in contemporanea, suggerendoti l'ordine ed il tempo corretto di inserimento e fuoriuscita della singola teglia.

This function allows you to cook different dishes at the same time, suggesting the right order and the right time to put in/remove from the oven individual trays.



ALL START

La cottura inizia nello stesso momento per tutti i piatti, il forno avverte quando ciascun piatto è pronto per essere servito.

Cooking starts at the same time for all dishes, and the oven warns the user when each dish is ready to be served.



11	00:24	
10	00:10	
9	—	65°
8	00:24	
7	00:10	
6	—	65°
5	—	50°
4	00:33	
3	00:06	
2	—	
1	00:14	

ALL END

La cottura finisce nello stesso momento per tutti i piatti, il forno avverte quando ciascun piatto deve essere inserito.

Cooking ends at the same time for all dishes, and the oven warns the user when each dish should be put in.



11	00:24	
10	00:10	
9	—	65°
8	00:24	
7	00:10	
6	—	65°
5	—	50°
4	00:33	
3	00:06	
2	—	
1	00:14	

MULTI END

La cottura finisce in momenti diversi per ciascun livello. Una volta impostato il Multi Cooking lo puoi salvare e usare quando vuoi.

Cooking ends at different times for each level. Once Multi Cooking has been set it can be stored and used at any time.

SOLUZIONI SMART PER IL TUO LAVORO

SMART SOLUTIONS
FOR YOUR WORK



MANIGLIA ERGONOMICA

Il reparto R&D di Inoxtrend ha studiato la soluzione migliore per una cucina dinamica in modo da garantire la massima comodità durante le concitate ore del servizio: la maniglia ergonomica brevettata, a doppia impugnatura, ti permette di aprire il forno anche con le mani occupate.



ERGONOMIC HANDLE

Inoxtrend's R&D team has studied the best solution for a dynamic kitchen in order to guarantee maximum comfort during hectic service time: the patented ergonomic handle, with double grip, allows you to open the oven even with your hands full.

PROGRAMMI DI LAVAGGIO

Il sistema di lavaggio automatico è studiato per far risparmiare risorse all'utente finale e per rispettare l'ambiente, vi farà ottenere una perfetta pulizia della camera di cottura indipendentemente dal suo livello di sporco. Potrete scegliere tra 5 programmi disponibili quello più adatto alla vostra necessità.

WASHING PROGRAMS

The automatic washing system is designed to help the end user save resources and respect the environment; it helps to achieve perfect cleaning of the cooking chamber regardless of its level of dirt. You can choose from 5 available programs the one best suited to your needs.

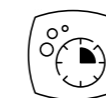
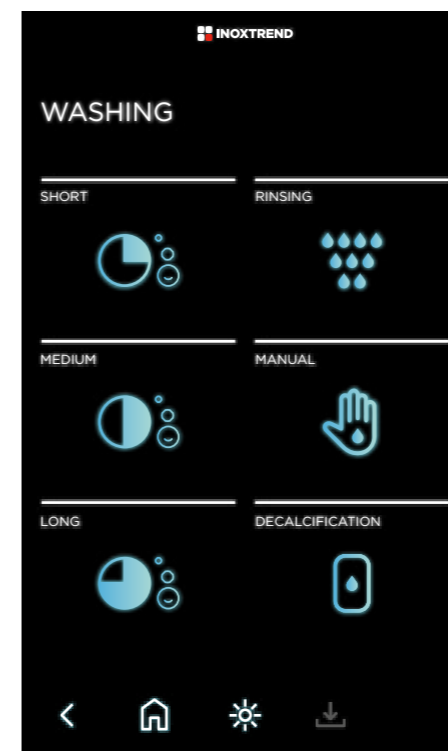

LAVAGGIO BREVE

SHORT WASHING

Questo programma è indicato in caso di lavaggio quotidiano del forno e/o di un basso livello di sporco. Nei forni con lavaggio a pastiglie richiede l'uso di 1 pastiglia di detergente.

This program is suitable for daily washing of the oven and/or for a low level of dirt. Ovens with tablet washing require the use of 1 detergent tablet.

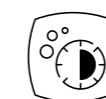

LAVAGGIO MEDIO

MEDIUM WASHING

Questo programma è indicato in caso di lavaggio non molto frequente con un livello medio di sporco. Nei forni con lavaggio a pastiglie richiede l'uso di 2 pastiglie di detergente.

This program is suitable for infrequent washing with an average level of dirt. Ovens with tablet washing require the use of 2 detergent tablets.



LAVAGGIO LUNGO

LONG WASHING

Questo programma è indicato in caso di lavaggio poco frequente. A seconda della quantità di sporco accumulata potrebbe essere necessario ripetere il ciclo più di una volta. Richiede l'uso di 3 pastiglie di detergente.

This program is suitable for infrequent washing. Depending on the amount of dirt accumulated, it may be necessary to repeat the cycle more than once. Requires the use of 3 detergent tablets.



RISCIACQUO

RINSING

Questo programma non utilizza né detergente né brillantante. Si tratta di una funzione studiata per rimuovere leggeri residui di cibo della cottura precedente.

This program does not use neither detergent nor rinse aid. This is a function designed to remove light food residues from previous cooking.



LAVAGGIO MANUALE

MANUAL WASHING

Questo programma è indicato qualora esaurite il detergente fornito da Inoxtrend. Selezionando questo programma, il forno vi avviserà quando vaporizzare il detergente da voi scelto all'interno della camera.

This program is recommended if you run out of detergent supplied by Inoxtrend. By selecting this program, the oven will notify you when to vaporize the detergent you have chosen inside the chamber.

OPZIONI E ACCESSORI

OPTIONS AND ACCESSORIES

TEGLIA ANTIADERENTE IN LEGA LEGGERA

NON-STICK BAKING TRAY
IN LIGHT ALLOY

Ideale per cottura di tutti
i prodotti, riducendo la
quantità di condimenti
grassi. Di facile pulizia.

Ideal for cooking all
products, reducing
the amount of fatty
condiments. Easy to clean.

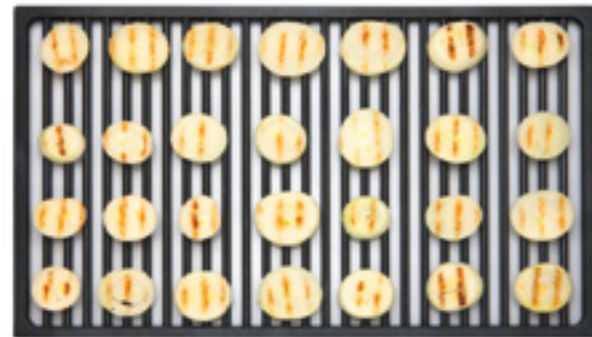

GRIGLIA ANTIADERENTE

NON-STICK GRILL

Ideale per verdure,
pesce e carne alla griglia.

Ideal for grilled vegetables,
fish and meat.

TEGLIA ANTIADERENTE DOUBLE FACE

DOUBLE-SIDED
NON-STICK BAKING TRAY

Liscia per cotture
alla piastra e rigata
per alla griglia.

Smooth for grilling
and ribbed for grilling.



TEGLIA RIGATA ANTIADERENTE

NON-STICK
LINED TRAY

Ideale per verdure,
pesce e carne alla griglia.
La struttura della griglia
permette di mantenere
i liquidi di cottura e la sua
pulizia è molto facile.

Ideal for grilled
vegetables, fish and
meat. The structure of
the grill allows to keep
the cooking liquids
and to easily clean it.

CESTELLO INOX FORATO

WIRE MESH STAINLESS
STEEL BASKET

Ideale per tutti i tipi
di frittura e cottura
al vapore.

Ideal for all types
of frying and steam
cooking.



TEGLIA A 6 INVASI IN ALLUMINIO

6-PAN ALUMINUM
TRAY

Per cuocere fino a 6
frittate, uova occhio
di bue, rosti di verdure.

For cooking up to 6
omelettes, bull's-eye
eggs, vegetable rosti.

TEGLIA PIEGATA SMALTATA

FOLDED ENAMELLED
TRAY

Ideale per cotture
prolungate. La finitura
granito permette una più
facile pulizia della teglia.

Ideal for prolonged
cooking. The granite
finish allows easier
cleaning of the tray.





KIT SOVRAPPOSIZIONE
STACKING KIT

DOCCIONE
HAND SHOWER

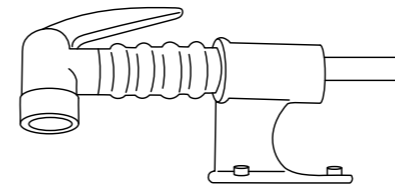

FILTRO GRASSI
FAT FILTER

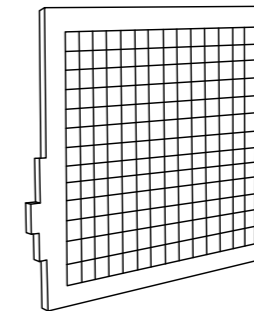

CAPPA ASPIRAZIONE CON FILTRO
SUCTION HOOD

**CAPPA CON
CONDENSAZIONE VAPORE**
SUCTION HOOD WITH
STEAM COANDENSATION

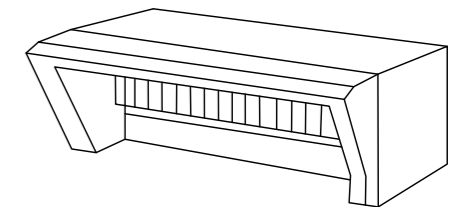

PORTATEGLIE
TRAY SLIDES

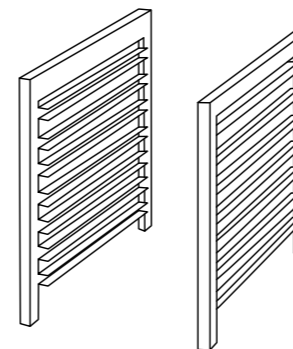

SUPPORTO APERTO
OPEN STAND

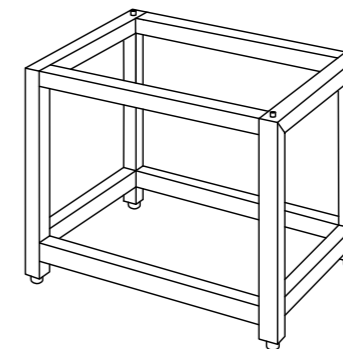

SUPPORTO CON RIPIANO
STAND WITH SHELF

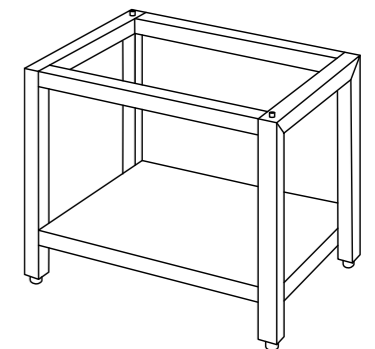

CUCINARE, ARROSTIRE, GRIGLIARE. COOKING, ROASTING, GRILLING.

I NOSTRI PRODOTTI

FORNI DECK A GAS
FORNI DECK ELETTRICI
FORNI A TUNNEL
SPIRAL MIXER
PLANETARIE
SPEZZATRICI
ARROTONDATRICI
DILAMINATRICI
PIZZA PRESS
AFFETTATRICI
TAGLIA VERDURE
MIXER
UTENSILI

OUR PRODUCTS

GAS DECK OVENS
ELECTRIC DECK OVENS
TUNNEL OVENS
SPIRAL MIXERS
PLANETARY MIXERS
DIVIDERS
ROUNDERS
DOUGH ROLLERS
PIZZA PRESSES
SLICERS
VEGETABLE CUTTERS
MIXERS
TOOLS

Inoxtrend Srl reserves
the right to make use of, necessary
modifications at any time to improve
its products, at any time,
and without prior notice.

Inoxtrend Srl si riserva il diritto
di apportare in qualsiasi momento
le modifiche utili e necessarie
al perfezionamento dei prodotti.

Inoxtrend S.r.l.
Via Serenissima 1,
31025 Santa Lucia di Piave TV
Italy

T +39 0438 456990
info@inoxtrend.com

a SOMEK group
company



SOMEK SpA (EXM ticker: SOM)
è un gruppo di società specializzate
nell'ingegnerizzazione, progettazione
e realizzazione di progetti costruttivi
chiavi in mano in ambito navale e civile,
in tre segmenti di commessa: sistemi
ingegnerizzati di architetture navali
e facciate civili, sistemi e prodotti
di cucine professionali, progettazione
e creazione di interior personalizzati.
Le società di SOMEK gruppo
operano secondo rigorosi standard
di accreditamento per posizione
finanziaria e scala operativa, e di
certificazione per qualità, sicurezza
e sostenibilità ESG. SOMEK è qualità
costruttiva italiana.

SOMEK SpA (EXM ticker: SOM)
consists of a group of companies,
specialized in the engineering,
design and execution of turnkey
naval and civil construction
projects, in three project sectors:
engineered systems of naval
architecture and building façades,
professional kitchen systems
and products, design and creation
of bespoke interiors. SOMEK group
companies are credited on Tier 1
Suppliers lists of the main shipyards
and building companies in the
world and quality, safety and ESG
sustainability certified. SOMEK
means Italian construction quality.

/// SOMEK
GRUPPO

Compatech è un forno elettrico compatto e sovrapponibile. Un concentrato di affidabilità, prestazioni culinarie e tecnologia.

Compatech is a compact and stackable electric oven. Quintessential reliability, culinary performance and technology.